

Ministry of education

Mubarak Al-Kabeer Edu. Zone

Aisha Al-Shareef School

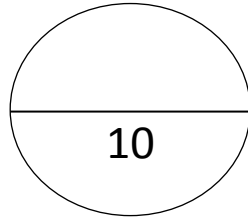

Third Period

Grade One

Quiz

Name:.....

Class: .....

I-Listening

A) Listen and tick the correct pictures (2 x 1 = 2):

1-She is eating .

2-It's a pencil.

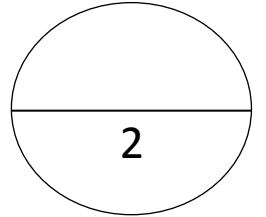

1-

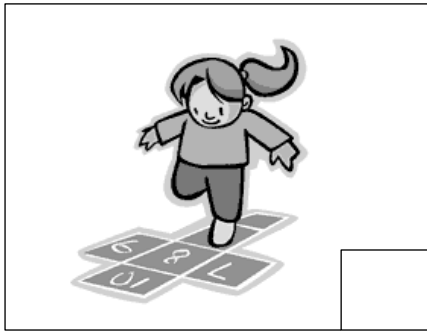

2-

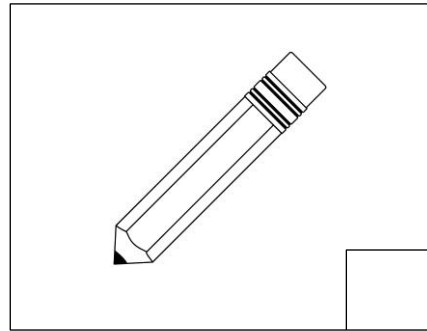

B) Listen and number the pictures (2 x 1 = 2):

1-It's a duck.

2-It's a dog.

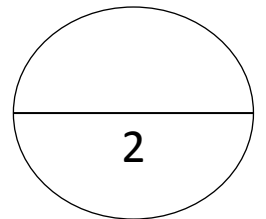

1-

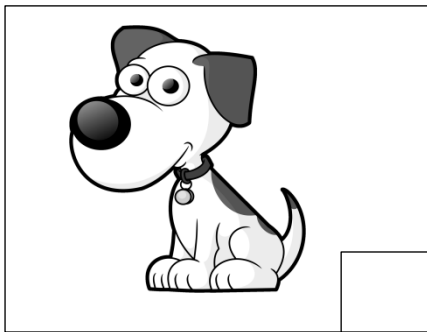

2-

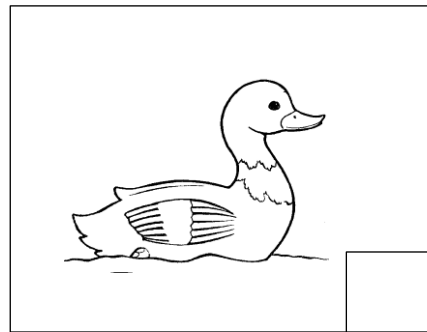

**II-Reading**

**A) Match upper & lower case letters : (4x $\frac{1}{2}$ =2)**

J c

C p

K j

P k

**B) Match pictures with words initials: (4x $\frac{1}{2}$ =2)**

1-Walk.



2-Jump.



3-Cat.



4-Kick.

